

INSTRUCTION MANUAL

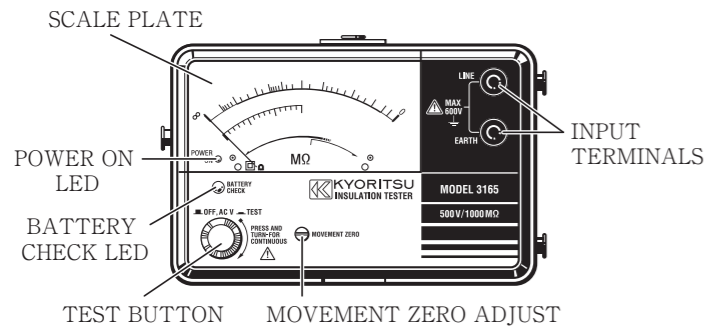

ANALOGUE INSULATION TESTERS

MODEL 3165 3166

1. Safety Precautions

- This instruction manual contains warnings and safety rules that must be observed by the user to ensure safe operation of the instrument and retain it in safe condition. Therefore, read these operating instructions thoroughly and completely before using the instrument.
- The symbol ⚠ on the instrument means that the user must refer to the relevant section of this instruction manual for safe operation of the instrument.
- Pay particular attention to all WARNINGS and CAUTIONS in this instruction manual. WARNING indicates warnings to avoid electrical shock and CAUTION indicates cautions to avoid damage to the instrument.

4-3 Insulation Resistance Measurement

⚠ WARNING
To avoid electrical shock, do not touch the test lead tips and the circuit under test during measurement.

⚠ CAUTION
To avoid damage to the instrument, insulation measurement must be performed on de-energized circuits only. Make sure that the circuits or equipment is disconnected before proceeding with an insulation test.

- (1) Connect the test leads to the instrument and the circuit under test.

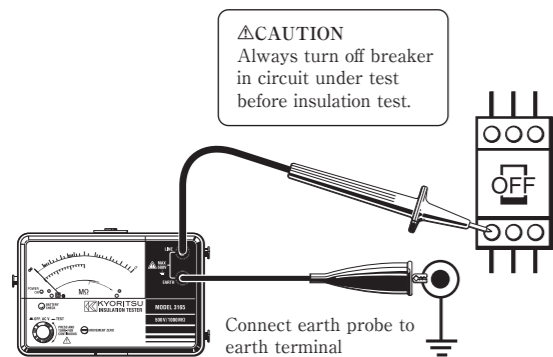

- (2) Check the circuit under test is not energized as follows. Connect the test leads to the circuit under test and read a voltage value. If the circuit is live, the meter indicates the voltage. If the meter indicates 0V, the circuit is dead.
- (3) Press test button. Read the red megaohm scale directly.
 - Continuous Measurement
A lock down feature is incorporated on the test button. Pressing and turning it clockwise lock the test button in the continuous operating position.

1. Always make sure to insert the plug of test leads fully into the terminal of the instrument.
2. Never exceed the maximum allowable input of any measuring range when making measurement.
3. Make sure to never apply a voltage more than 600V AC or DC between the terminal of the instrument and earth.
4. Never try to operate the instrument in an explosive atmosphere (i. e. in the presence of flammable gases or fumes, vapor or dust).
5. Always inspect the instrument, test leads and accessories for any sign of damage or abnormality before every use. If abnormal conditions exist (e. g. broken test leads, cracked enclosure of the instrument), do not try to make measurements.
6. Do not push the test button or lock it down while connecting test leads.
7. Do not touch the circuit under test during insulation testing.
8. Make sure to remove the test lead from the instrument and turn the power off before opening the battery compartment cover for battery replacement.
9. Always turn the power off after use.
10. Do not expose the instrument to the direct sun, dew fall, or extreme temperatures.
11. Do not expose the instrument to a temperature of more than 50°C.
12. Calibration and repair of any instrument should only be performed by qualified and trained service technicians.
13. Do not install substitute parts or perform any unauthorized modification of the instrument. Return the instrument to your distributor for service and repair to ensure that safety features are maintained.
14. The instrument must be used by a competent, trained person and operated in strict accordance with the instructions. KYORITSU will not accept liability for any damage or injury caused by misuse or noncompliance with the instructions or safety procedures. It is essential to read and understand the safety rules contained in the instructions. They must be observed when using the instrument.

2. Features

- AC voltage measurement can be made without depressing the test button.
- Battery check facility.
- Uses only 4x1.5V battery type R6, AA or equivalent.

3. Specifications

- Measuring ranges accuracy (at 23±5°C, relative humidity 45-75%)

To release the lock turn the test button counter clockwise. Never leave the test button locked down when not in use.

- (4) Discharging capacitance of circuit under test.
It is possible that capacitance has been stored in the circuit under test after insulation testing. To discharge the circuit capacitance reverse the connection of the earth clip and line probe. Remaining electric charges can be observed on AC voltage warning range.

⚠ WARNING
Do not touch the circuit under test immediately after testing. Capacitance stored in the circuit may cause electric shock.

5. Battery Replacement

⚠ WARNING
To avoid shock hazard disconnect the test leads from the instrument.

To replace the batteries, first disconnect all test leads from the instrument. Open the battery compartment cover by unscrewing the metal captive screw to reveal battery compartment. The four 1.5V SUM-3(R6) type batteries are located in a compartment. Always replace all four batteries with new ones at the same time. Never mix old and new ones. Screw the battery compartment lid back on before using the instrument.

Fixing Screw

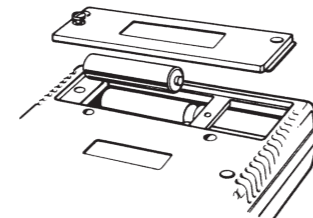

⚠ CAUTION
Install battery in correct polarity as marked inside the case.

Insulation resistance ranges:

	MODEL 3165	MODEL 3166
Test voltage	500V	1000V
Measuring range	1000MΩ	2000MΩ
Mid-scale value	20MΩ	50MΩ
Output voltage on open circuit	Rated test voltage +20% -0%	
Output short circuit current	240μA max	550μA max
Primary Effective Measuring Range	1-500MΩ	2-1000MΩ
Accuracy	±5% of indicated value at primary effective measuring range ±0.7% of scale length at 0 and ∞ ±10% of indicated value at other measuring range	

AC Voltage Warning:

Warning range	0-600V AC
Accuracy	± 3% of scale length

Power supply	4x1.5V battery type SUM-3,R6,AA or equivalent
Overload protection	Insulation Resistance Ranges Model 3165: 600V (DC+ACp-p) for 10 seconds Model 3166:1200V (DC+ACp-p) for 10 seconds AC Voltage Range 720V (DC+ACp-p) for 10 seconds
Operating temperature & humidity	0-40°C, relative humidity up to 85%
Storage temperature & humidity	-10-50°C, relative humidity up to 75%
Withstand voltage	3700V AC for one minute between electrical circuit and housing case
Insulation resistance	More than 50MΩ at 1000V between electrical circuit and housing case
Dimensions	90(L)×137(W)×40(D)mm
Weight	330g
Accessories	Test leads Model 7025(1 set) Pouch for test leads (1 piece) Shoulder strap (1 piece) R6 batteries (4 pieces) Instruction manual (1 copy)

4. Operation

- 4-1 Preparation for testing
 - (1) Mechanical zero adjustment
Without pressing the Test button, check that the pointer lines up with

6. Notes on Housing Case & Accessories

- 6-1 Case Lid
Case lid can be fit under the housing case as illustrated below.

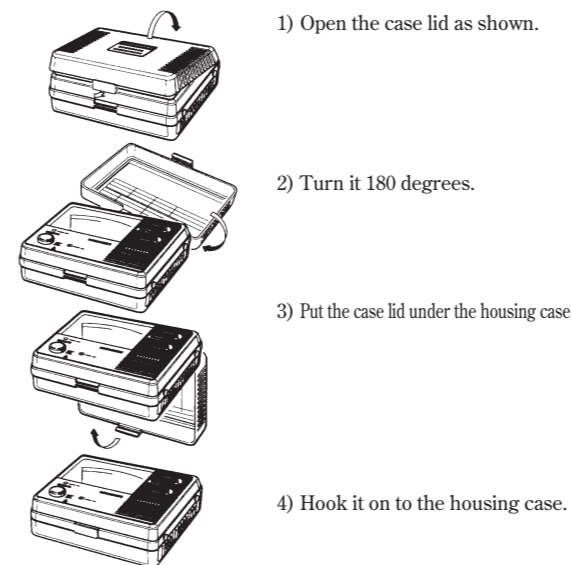

- 6-2 How to fit Neck Strap & Test lead Pouch
 1. Fit the neck strap as shown.

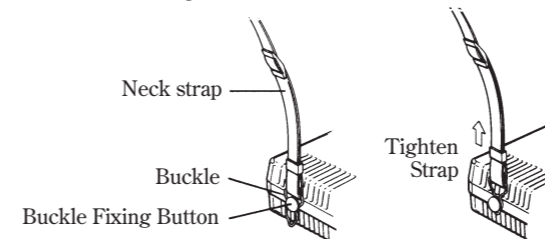

- the ∞ mark on the red megaohm scale. If not, adjust it by rotating the meter movement zero adjust with a screwdriver.
- (2) Test lead connection
Insert the test leads into the terminals of the instrument.
- (3) Battery voltage check
Battery check LED flashes at insulation resistance testing to indicate normal battery condition. Replace the batteries when the LED stops flashing. Replace the batteries according to section 6 for battery replacement.
- (4) Test leads check
Press and turn the Test button to lock it down. When the test leads are connected together, the pointer should move from the ∞ position towards the 0 position on the megaohm scale. If not, the leads may be faulty. Release the Test button after completion.

⚠ WARNING
When the Test button is pressed, take care not to touch the tip of the test lead where a high voltage is present in order to avoid possible shock hazard.

4-2 AC Voltage Warning Function

⚠ WARNING
Never depress the test button when voltage is present on the circuit under test.

- (1) The presence of AC voltage can be detected. This function operates automatically when the test button is not depressed, i.e., in the up position.
- (2) Using the test leads, connect EARTH terminal to the earth side of the circuit under test and LINE terminal to the line side.
- (3) Take the reading on the AC voltage scale.

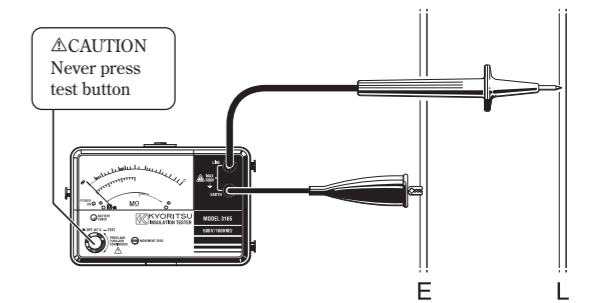

2. Fit the test lead pouch to the housing case as shown.

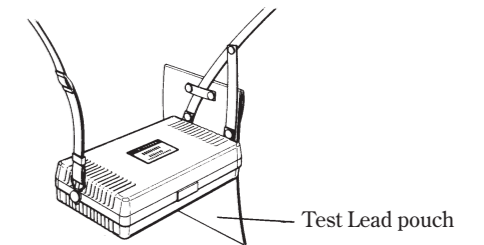

7. Servicing & Calibration

If this tester should fail to operate correctly, return to your distributor, stating exact nature of fault. Make sure that:-

- Operating instructions have been followed
- Leads have been inspected
- Batteries have been checked
- The unit is returned with all accessory leads

Note : Since the meter cover has been given an anti-static treatment do not rub it strongly with dry cloth to remove dust or dirt. If electrostatic charges are present on the cover, wipe it with a soft cloth wet with anti-static solution.

KYORITSU reserves the right to change specifications without prior notice.

KYORITSU ELECTRICAL INSTRUMENTS WORKS, LTD.

No.5-20,Nakane 2-chome, Meguro-ku,
Tokyo, 152-0031 Japan
Phone: +81-3-3723-0131
Fax: +81-3-3723-0152
Factory: Ehime,Japan

www.kew-ltd.co.jp